



## Product Report and Basic Points about “KZR-CAD NANOZR”

**Achieving High-strength Zirconia with  
Excellent Impact Resistance**

### **YAMAKIN CO., LTD.**

Head Office: 3-7 Sanadayama-cho Tennoji-ku Osaka 543-0015, Japan  
Biological Science Safety Laboratory:  
Laboratory in the Department of Oral and Maxillofacial Surgery, Kochi Medical School, Kochi University  
Kohasu, Oko-cho, Nankoku-shi, Kochi 783-8505, JAPAN  
Branch Office: Tokyo, Osaka, Sendai, Nagoya, Fukuoka, JAPAN  
P: +81-887-55-0281 F: +81-887-55-0053  
E: [contact@yamakin-gold.co.jp](mailto:contact@yamakin-gold.co.jp)

## Index

1. Introduction . . . . .	2
2. Material characteristics . . . . .	6
3. Mechanical properties . . . . .	7
3.1 Basic characteristics of zirconia . . . . .	7
3.2 Impact resistance confirmed by ball drop test . . . . .	15
3.3 Breaking coping test assuming clinical practice . . . . .	17
4. Chemical properties . . . . .	18
5. Hydrothermal deterioration resistance property . . . . .	19
6. Adhesion . . . . .	20
7. Biocompatibility . . . . .	22
8. Conclusion . . . . .	24

### Supervision

#### YAMAKIN Ph. D. Group

Teruo Anraku (Ph. D. in Engineering)  
Hiroyuki Itoigawa (Ph. D. in Science)  
Takahiro Kato (Ph. D. in Engineering)  
Takeshi Sakamoto (Ph. D. in Pharmacy)  
Yuji Sato (Ph. D. in Philosophy)  
Hidekazu Tanaka (Ph. D. in Engineering)  
Ritaro Matsuura (Ph. D. in Agriculture)  
Masatoshi Yamazoe (Ph. D. in Dentistry)  
Hirohisa Yamamoto  
(Ph. D. in entrepreneur engineering)

#### Advisor of YAMAKIN Ph. D. Group

Bunichiro Yamada (Ph. D. in Engineering)

### What is the YAMAKIN Ph. D. Group?

This is a group of experts in various specialized fields who combine their knowledge, experience and technical expertise to act as a prime mover in the continuous generation of innovation.

# Basic points about “KZR-CAD NANOZR” and Product Report

Yamazoe, M., Ph. D. in Dentistry, Executive Officer, Head Researcher, Academic Department  
Kato, T., Ph. D. in Engineering, Executive Officer, Head Researcher, Development Department  
Matsuura, R., Ph. D. in Agriculture, Senior Chief Researcher, Biological Science and Safety Laboratory  
Tanaka H., Ph. D. in Engineering, Chief Researcher, Development Department  
Narikiyo H., Master of Engineering, Project leader, Inorganic Material Development Section

## 1. Introduction

In case of tooth loss due to caries, periodontal disease, or accidents, the role of dental prostheses is to use artificial materials to restore the shape, mechanical function, and aesthetic function of missing teeth. In the field of dental care, significant emphasis is placed on the appearance of the prosthesis, including aesthetic blending with adjacent teeth and reproduction of the coloration of natural teeth.

Aesthetic dental treatment satisfies the public demand for whitened teeth, and contributes to improving quality of life. In such treatment, porcelain-fused-to-metal crowns have long been used for repairing teeth. However, because porcelain-fused-to-metal crowns have a metal frame, the gingiva near the cervical part is liable to appear dark and gingiva blackening may occur where the metal comes into contact with the gingiva. Furthermore, since the prosthesis is continuously present in the harsh environment of the oral cavity over long periods, metal allergy due to the eluate from the metal frame is regarded as a problem, and new methods of metal repair have been sought.

The affinity and compatibility of dental materials to the living body are important issues, as well as the functional expression of these materials as a prosthesis. Biological harmfulness such as metal allergy is caused by the biological or chemical change of materials in the oral environment, and the metal components contained in the material may induce change in the body tissue by dissolution or physical contact<sup>1)</sup>.

In recent years, all-ceramic prostheses that do not use metal, known as metal-free prostheses, have been widely applied clinically in order to advance high-precision processing technology through the CAD/CAM system and to reduce the risk of metal allergy<sup>2)</sup>. In general, due to their excellent chemical stability and mechanical properties, ceramics have become widely used as an alternative material at sites where metallic materials have previously been used, for purposes such as implant materials and artificial joints. However, one disadvantage of ceramics is that their tensile strength and impact strength are inferior to metal materials. Since ceramic is a hard and brittle material, its long-term reliability is poor, and there are constraints on its use for parts requiring impact resistance.

Fracture toughness functions as an index for evaluating impact strength, that is, brittleness. Tetragonal zirconia (Y-TZP), which uses yttria as a stabilizer, can be mentioned as a ceramic material with high

fracture toughness value<sup>3)</sup>. When stress is applied to Y-TZP, the crystal structure of tetragonal to monoclinic crystal occurs with about 4% volume expansion, and compressive stress is generated around it. This is called stress-induction phase transformation, and compressive stress acts on the tip of the generated crack, thereby preventing crack propagation. On the other hand, Y-TZP exhibits excellent chemical stability as a ceramic material, but in a hydrothermal environment, characteristics of low-temperature degradation are known in which the phase transformation is promoted from a tetragonal to a monoclinic crystal, degrading its mechanical properties. This phase transformation is considered as one of the causes of the deterioration of strength. In order to function stably in the harsh environment of the oral cavity over the long term, excellent durability is required, and this low-temperature degradability is one of the factors causing instability.

Ceria-stabilized tetragonal zirconia-based nanocomposite ceramic (nano-zirconia) was developed by Nawa, et al<sup>4,5)</sup>. This material incorporates nano-sized alumina particles into the crystal grains of tetragonal zirconia (Ce-TZP), which are stabilized with ceria. Similarly, nano-sized Ce-TZP particles are incorporated into alumina crystal grains; as a result, nano-zirconia has high fracture toughness and excellent resistance to low-temperature degradation<sup>6)</sup>. These characteristics enable a frame thickness of 0.3 mm—similar to metal—to be made using nano-zirconia as the frame of the prosthesis and enables reduction of the cutting amount of abutment teeth.

As described above, although nano-zirconia has excellent mechanical properties compared with Y-TZP, it has minimal translucency, which is important in tooth color reproduction. For this reason, it is essential to use porcelain materials for facing teeth, in combination with dental techniques to reproduce the color tones of natural teeth or adjacent teeth. By contrast, this opacity can negate the influence of the material and color of abutment teeth, so there is the advantage that it can be done using same building techniques as fabricating crowns made of porcelain-fused-to-metal. Therefore, nano-zirconia—which has excellent mechanical properties and biocompatibility—appears to be of very high clinical value as a useful substitute for metal. We would be pleased if this report helps to inform practitioners about technical information such as why nano-zirconia is different from the yttria-type zirconia widely used in dentistry, and why nano-zirconia exhibits such characteristics.

Note: “KZR-CAD NANOZR” is an original product of YAMAKIN CO., LTD.

Product line-up and processing examples of “KZR-CAD NANOZR”

"KZR-CAD NANOZR" has the greatest line-up of thicknesses (10 types) in the "KZR-CAD series," and its sturdy mechanical features and precise machining accuracy are deployed for use in a wide range of applications, including single crowns to long-span bridge frames, etc. This is a photograph of a typical example of this product in use.



Appearance of KZR-CAD NANOZR



Line-up of thicknesses of KZR-CAD NANOZR



NANOZR disc and examples of processing



Bridge frame made of NANOZR



NANOZR frames with an access hole



NANOZR bridge (Left: frame; Right: building up with porcelain)



Bone-anchored bridge frame and abutments  
(Fixed with a titanium base abutment and resin cement)



## 2. Material characteristics

The raw material powder of NANOZR is an original product manufactured by Daiichi Kigenso Kagaku Kogyo Co., Ltd. It mainly consists of zirconium oxide ( $ZrO_2$ ), cerium oxide ( $CeO_2$ ) as a stabilizer, and also alumina ( $Al_2O_3$ ). The overall ratio is shown in Table 1. Since alumina is present at 10 wt% or more, there is no translucency, and the color tone is pale yellow due to the effect of cerium oxide. The crystal structure is the eutectic of tetragonal zirconia and alumina. In addition, toughening is achieved by the formation of a nanocomposite structure in which the respective nanoparticles mutually diffuse in zirconia and alumina particles. Figure 1 is an image of a nanocomposite structure, and Figure 2 is an SEM image (S-3500N: Hitachi High-Technologies Corporation) of sintered NANOZR.

Table 1 Composition of NANOZR

Components	Ratio(wt%)*
$ZrO_2 + HfO_2$	76.6
$CeO_2$	11.0
$Al_2O_3$	12.4
$Fe_2O_3$	0.03

\*XRF

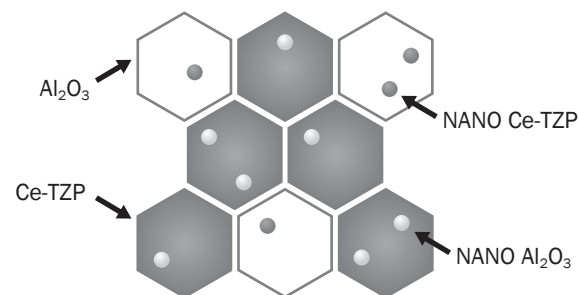

Figure 1 Image of a nanocomposite structure

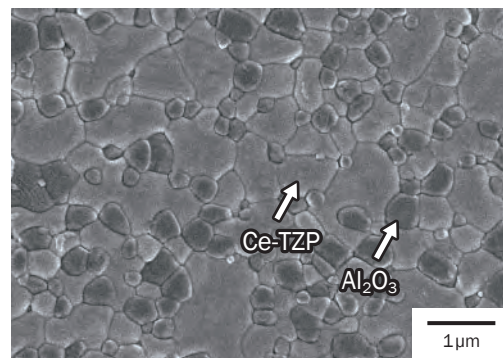

Figure 2 SEM image of sintered NANOZR

## 3. Mechanical properties

### 3.1 Basic characteristics of zirconia

For evaluation of the mechanical properties of zirconia products, "KZR-CAD zirconia" T, HT, and SHT—which are yttria-type zirconia—and NANOZR were prepared as test specimens for comparison. As an evaluation of mechanical properties, sintered density, linear thermal expansion coefficient, bending strength, Vickers hardness, and fracture toughness were evaluated, and impact tests were carried out by dropping steel balls (ball drop test). Also, the fracture strength test of the sintered body modeled after a single crown coping, assuming a molar tooth, was carried out.

Table 2 Material properties of each sintered zirconia

	NANOZR	T	HT	SHT	Note
Appearance					Thickness of test specimen: 0.5 mm
Transmittance (%)	0	33	43	51	Thickness of test specimen: 1 mm
Density ( $g/cm^3$ )	5.54	6.06	6.07	6.03	By the Archimedean Method
Relative density (%)	100	99.9	99.9	99.8	
Linear thermal expansion coefficient ( $\times 10^{-6}/^{\circ}C$ )	10.1	10.8	10.8	10.2	ISO 6872: 2015 <sup>8)</sup>
Biaxial flexure strength (MPa)	1270	1380	1370	850	ISO 6872: 2015 <sup>8)</sup>
Three-point bending strength (MPa)	1110	1280	1080	770	ISO 6872: 2015 <sup>8)</sup>
Vickers hardness (HV)	1240	1340	1370	1410	ISO 14705: 2016
Fracture toughness ( $MPa \cdot m^{1/2}$ )	12.1	4.5	4.3	2.6	ISO 15732: 2003
	21.3	5.5	5.4	3.2	IF 法 <sup>11)</sup>
Chemical solubility ( $\mu g/cm^2$ )	1.0	4.0	2.4	4.5	ISO 6872: 2015 <sup>8)</sup>

A range of different appearances of sintered zirconia (thickness: 0.5 mm) is shown in Table 2. NANOZR has a pale yellow color tone and is opaque so that lines drawn under the test specimen cannot be visually recognized. On the other hand, T, HT, and SHT are white and translucent, and lines drawn under the test specimens can be seen. In particular, it can be confirmed that SHT has higher light transmission than T and HT. Since NANOZR, with a thickness of 1 mm, does not exhibit translucency, it is not suitable for crown bridges as monolithic zirconia from an aesthetic point of view. However, sufficient aesthetics can be obtained by using porcelain for zirconia in combination to build upon a crown, and firing it.

The density of each sintered zirconia specimen was measured by the Archimedes method. The relative density of each test specimen was 99.8% or more, and it was judged that there was no deterioration in light transmission due to residual pores.

The coefficient of thermal expansion was measured according to the standards for dental ceramic material, ISO 6872: 2015<sup>8)</sup>. For the test, four zirconia sintered specimens (4.0 mm × 4.0 mm × 20.0 mm) were prepared and temperature was raised from room temperature to 520 °C with heating at a rate of 5 °C/min and loading 147 mN with a thermomechanical analyzer (TMA 8310: Rigaku Corporation). The average coefficient of thermal expansion from 50 °C to 500 °C was then measured. The measurement results of the liner thermal expansion coefficient are given in Table 2.

Biaxial flexure test was carried out according to ISO 6872: 2015. The ten mirror-polished sintered zirconia specimens (diameter 14.0 mm, thickness 1.3 mm) were prepared and the test was carried out with a precision universal testing machine (Autograph AG-X: Shimadzu Corporation). As the test conditions, three hardened heat-treated steel balls with a diameter of 4.0 mm were positioned 120° apart on a support circle with a diameter of 11.0 mm. From the central upper surface of a test piece placed concentrically on this steel ball, the end face of a cylinder with a diameter of 1.4 mm was loaded onto the testing machine at a cross-head speed of 1.0 mm/min.

The biaxial flexure strength was calculated by the following equation (1). The Poisson's ratio  $\nu$  was set to 0.31 for each zirconia specimen. The results of the test are given in Figure 3.

$$\sigma = \frac{-0.2387P(X-Y)}{b^2} \quad (1)$$

where

$\sigma$  is the biaxial flexure strength [MPa].

$P$  is the total load causing fracture [N].

$X$  is  $(1+\nu) \ln(r_2/r_3)^2 + [(1-\nu)/2](r_2/r_3)^2$ .

$Y$  is  $(1+\nu)[1+\ln(r_1/r_3)^2] + (1-\nu)(r_1/r_3)^2$ .

$b$  is the specimen thickness at fracture origin [mm].

where

$\nu$  is the Poisson's ratio.

$r_1$  is the radius of support circle [mm].

$r_2$  is the radius of loaded area [mm].

$r_3$  is the radius of specimen [mm].

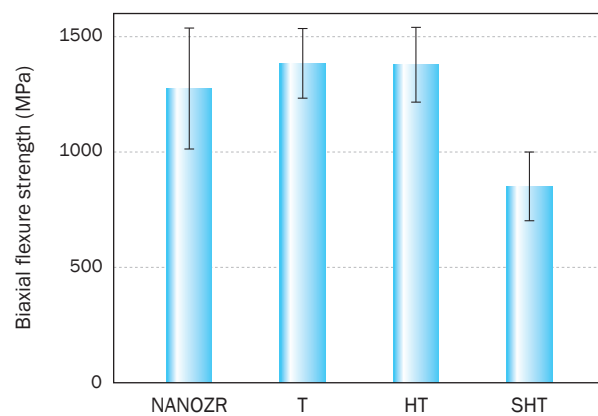

Figure 3 Biaxial flexure strength of each sintered zirconia specimen

For comparison, the three-point bending test was conducted according to ISO6872: 2015. Thirty mirror-polished sintered zirconia specimens (4.0 mm in width, 20.0 mm in length, 1.2 mm in thickness, chamfered by 1.0 mm) were prepared and a small desktop testing machine (EZ-Graph: Shimadzu Corporation) was used for testing.

As a test condition, a load was applied at cross-head speed of 1.0 mm/min using a jig having a support point distance of 14.0 mm, a support rod and a load plunger diameter of 1.6 mm.

The three-point bending strength was calculated by the following equation (2). The test result is given in Figure 4.

$$\sigma = \frac{3Pl}{2wb^2} \quad (2)$$

where

$\sigma$  is the three-point bending strength [MPa].

$P$  is the breaking load [N].

$l$  is the test span [mm].

$w$  is the width of the specimen [mm].

$b$  is the thickness of the specimen [mm].

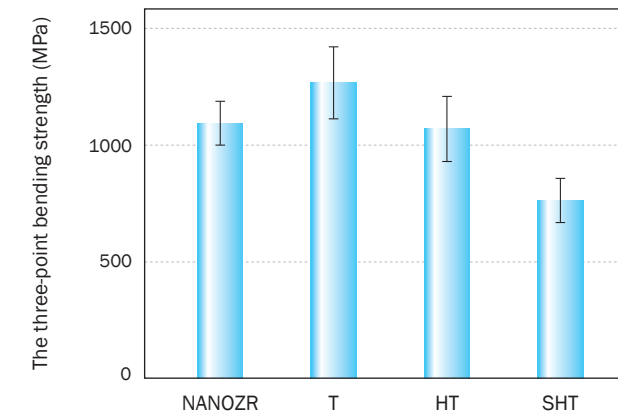

Figure 4 The three-point bending strength of each sintered zirconia specimen

Vickers hardness HV was tested according to ISO 14705: 2009<sup>9)</sup>, stipulating the hardness test method for fine ceramics. Using a microhardness tester (MVK-E II : Akashi Seisakusho, Ltd.), a Vickers indenter was pressed into a mirror-polished sintered zirconia specimen (10.0 mm × 10.0 mm × 1.0 mm) under the test force of 9.807 N and a loading time of 15 sec, then diagonal length of the indentation was measured. The test was carried out by press-fitting into 5 points on each sintered zirconia specimen, and the value was calculated from the measured values and the following equation (3) (Figure 5).

$$HV = 0.1891 \times \frac{F}{d^2} \quad (3)$$

where

HV is the Vickers hardness.

$F$  is the load force [N].

$d$  is the diagonal length of the indentation [mm].

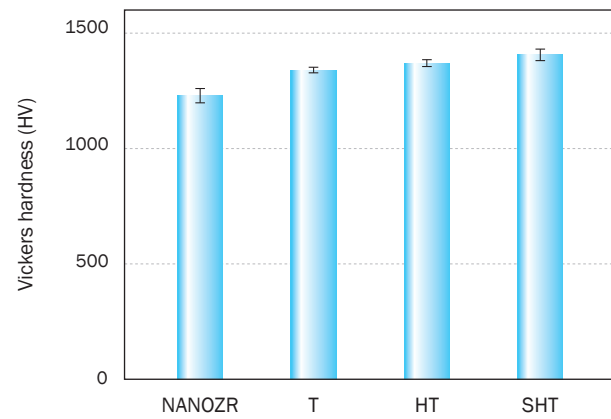

Figure 5 Vickers hardness of each sintered zirconia specimen

NANOZR has a structure of intergranular nanocomposites in which nano-sized Ce-TZP and  $\text{Al}_2\text{O}_3$  grains interpenetrate. Its biaxial flexural strength was 1270 MPa, and the three-point bending strength was 1110 MPa. Vickers hardness HV showed comparable values for each sample.

Fracture toughness value was mentioned at the beginning as an index to evaluate impact strength—that is, brittleness—tetragonal zirconia using yttria or ceria as a stabilizer shows a particularly high value among ceramics materials. This is due to the stress-induced phase transformation mechanism, and in ceramics it is a feature found only in zirconia.

While various methods for measuring fracture toughness value have been reported, in the ISO 6872: 2015 standard for dental ceramic materials, the Single-Edge V-Notch Beam (SEVNB) method is recommended, although it is not stipulated as an essential test. The Single-Edge Pre-cracked Beam (SEPB) method, Surface Crack in Flexure (SCF) method, and Chevron Notched Beam (CNB) method are also given as alternative methods for this test: however, it is considered that obtaining values by the crack length from the corner of the Vickers indentation is inadvisable.

On the other hand, the ISO 15732: 2003<sup>10)</sup> standard for the test method for room-temperature fracture toughness of fine ceramics specifies the SEPB method and the IF (Indentation Fracture) method to obtain from the crack length from the corner of the Vickers indentation.

The SEVNB method, recommended in the dental ceramic material standard ISO 6872: 2015, is very heavily influenced by the way in which the V notch tip is formed, and it is difficult to conduct testing with good reproducibility. Therefore, evaluation was carried out by the SEPB method, which was introduced as an alternative method in an annex of ISO 6872: 2015 mentioned above, and which was adopted in ISO 15732: 2003.

The fracture toughness test by the SEPB method was conducted with reference to ISO 15732: 2003. Figure 6 shows the shape of test pieces and Figure 7 is an image of a test jig.

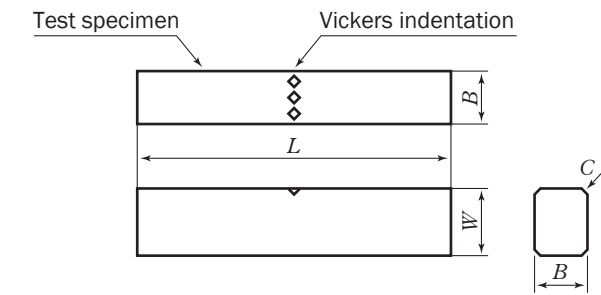

- $L$  : Overall length of test (40 mm)
- $B$  : Thickness of test specimen ( $3.0 \pm 0.1$  mm)
- $W$  : Width of test specimen ( $4.0 \pm 0.1$  mm)
- $C$  : Chamfering (0.1~0.3 mm)

Figure 6 Size of test specimen

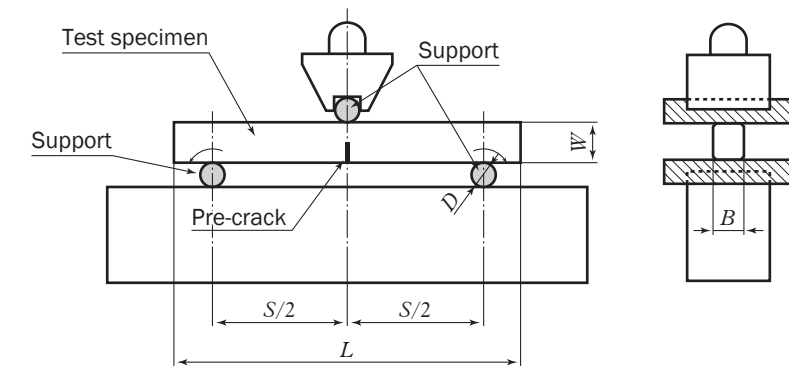

- $D$  : Diameter of support (4.0 mm)
- $S$  : Support point distance ( $16.0 \pm 0.2$  mm)

Figure 7 Testing jig

For the test, the procedures until the sintering of the test specimens were conducted in-house, and the procedures from the adjustment of the specimens to testing were carried out at JFCC (Japan Fine Ceramics Center). For introduction of pre-crack, the indentation load of Vickers indenter at 98 N was added for T, HT, and SHT. It was impossible to introduce pre-crack on NANOZR at 98 N; as a result, a pre-crack initiation point was introduced at 490 N and pop-in crack was introduced as pre-crack using a compression jig and an anvil. Fracture toughness value  $K_{Ic}$  was calculated using equation (4) (Figure 8).

$$K_{Ic} = \left( \frac{P \times S}{B \times W^{\frac{3}{2}}} \right) \times \left\{ \frac{3}{2} \left( \frac{a}{W} \right)^{\frac{1}{2}} \times Y \left( \frac{a}{W} \right) \right\} \quad (4)$$

$$Y \left( \frac{a}{W} \right) = \frac{[1.99 - \frac{a}{W} (1 - \frac{a}{W}) \times \{ 2.15 - 3.93 \frac{a}{W} + 2.7 (\frac{a}{W})^2 \}]}{(1 + 2 \frac{a}{W}) \times (1 - \frac{a}{W})^{\frac{3}{2}}}$$

where

- $K_{Ic}$  is the fracture toughness [ $\text{MPa} \cdot \text{m}^{1/2}$ ].
- $P$  is the breaking load [N].
- $S$  is the support span [m].
- $B$  is the specimen length [m].
- $W$  is the specimen width [m].
- $a$  is the pre-crack length [m].

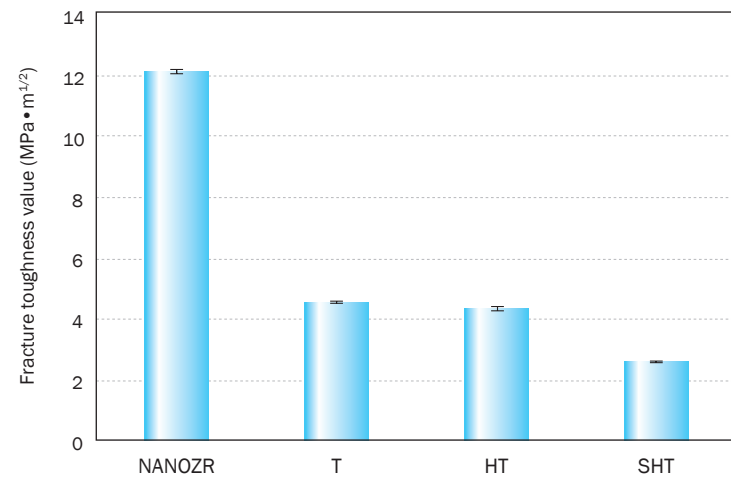

Figure 8 Fracture toughness value of each sintered zirconia specimen (SEP method)  
(Tested by JFCC (Japan Fine Ceramics Center))

In addition, in order to confirm the influence due to the difference in the test method, fracture toughness value  $K_{Ic}$ , obtained from the crack length from the corner of the Vickers indentation, is calculated from Niihara's equation<sup>11)</sup> (5) and (6) by IF method. Using a hardness tester (HV-113: Mitutoyo Corporation), a Vickers indenter was pressed into a mirror-polished sintered zirconia specimen (10.0 mm × 10.0 mm × 3.0 mm) under a test force of 196 N and a loading time of 15 sec; the indenter made indentation and cracks, and then length of the cracks was measured. The test was carried out by press-fitting into 5 points on each sintered zirconia specimen.

Figure 9 shows the optical micrographs of indentation caused by indentation fracture. The length of the crack from the corner of the indentation of NANOZR is shorter than that of T, HT, and SHT, which are made of yttria-type zirconia, and the indentation is close to that of a plastically deforming metallic material. On observation, the vertical section of the indentation had a semi-elliptical shape from the corner of the indentation to the crack tip, and it was an initially generated Palmqvist crack. On the other hand, T, HT, and SHT show long cracks from the corner of indentation compared to NANOZR. In observation of the vertical section of the indentation, a median crack showing a semicircular shape from the crack tip to the diagonal crack tip was confirmed. In particular, lateral cracks, which seems to have occurred at unloading, appear in a circle around the indentation, and median cracks and lateral cracks can be confirmed. Figure 10 shows images of crack shapes caused by breakage, (a): Palmqvist-crack, (b): Median crack, (c): Lateral crack.

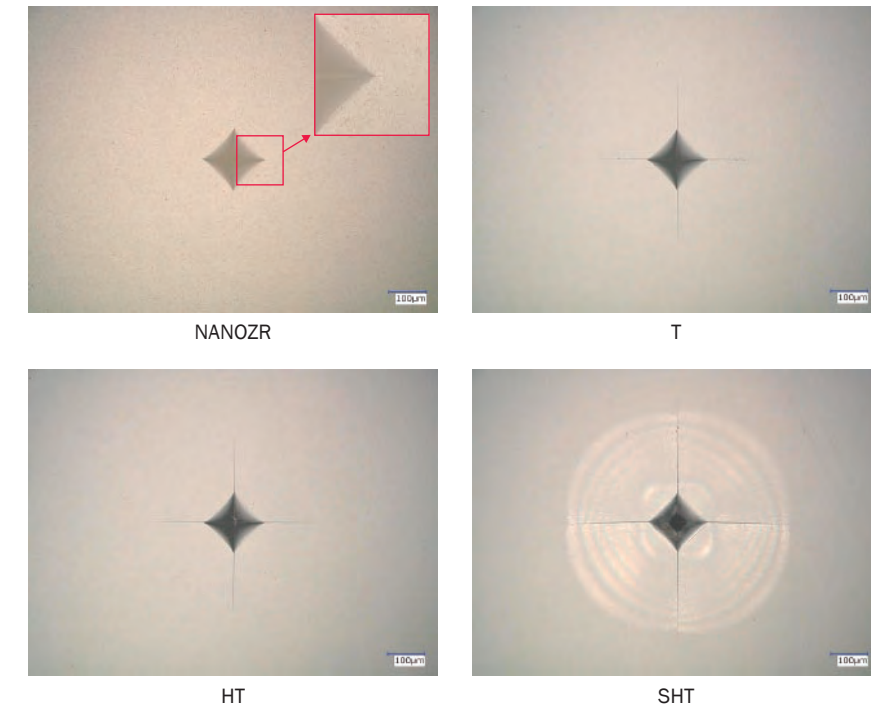

Figure 9 Optical micrograph images of indentation caused by indentation fracture

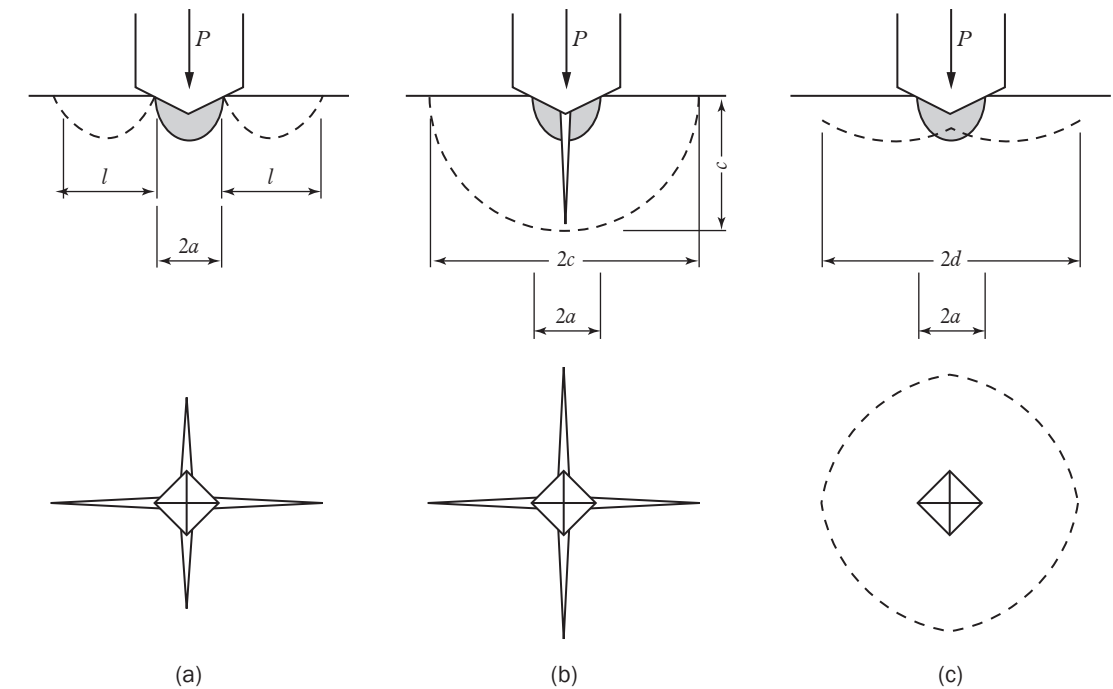

Figure 10 Images of crack shapes caused by breakage  
(a): Palmqvist crack, (b): Median crack, (c): Lateral crack.



In Palmqvist crack

$$\left(\frac{K_{Ic}}{H \times a^{\frac{1}{2}}}\right) \times \left(\frac{H}{E}\right)^{\frac{2}{5}} = 0.018 \times \left(\frac{l}{a}\right)^{-\frac{1}{2}} \quad (5)$$

In median crack

$$\frac{K_{Ic}}{H \times a^{\frac{1}{2}}} = 0.203 \times \left(\frac{c}{a}\right)^{-\frac{3}{2}} \quad (6)$$

$K_{Ic}$  is the fracture toughness [ $\text{MPa} \cdot \text{m}^{1/2}$ ].

$a$  is the half of diagonal length of indentation [m].

$c$  is the half of the crack length from the corner of the median crack [m].

$l$  is the half of the crack length from the corner of the indentation of the Palmqvist crack [m].

$E$  is Young's modulus [Pa].

$H$  is the Vickers hardness.

In NANOZR, the form of the crack generated by the indentation is the Palmqvist crack, and furthermore, the crack length is less than 1.5 times the diagonal length of indentation; thus, fracture toughness value  $K_{Ic}$  was calculated according to Niihara's equation (5).

On the other hand, in the yttria-based zirconia T, HT, and SHT, the form of crack was the median crack, and in each case, the crack length was larger than 2.5 times the diagonal length of the indentation, and fracture toughness was calculated from equation (6). Figure 11 gives the fracture toughness value calculated from Niihara's equation by the IF method.

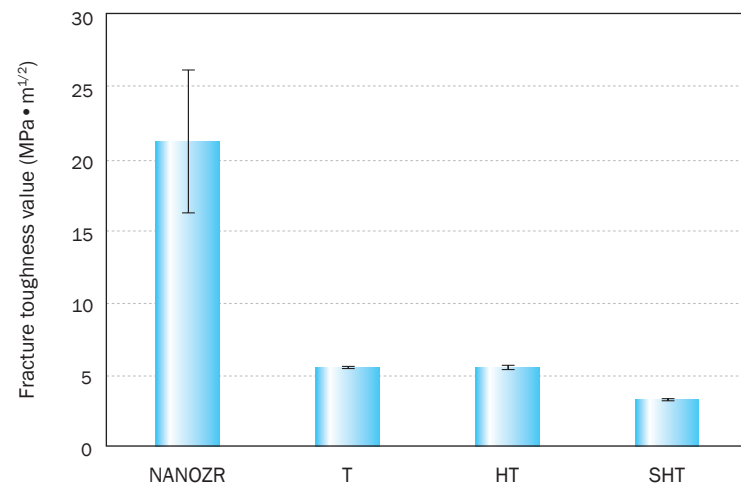

Figure 11 Fracture toughness value of each sintered zirconia specimen (IF Method)

### 3.2 Impact resistance confirmed by ball drop test

As an impact test (ball drop test), a sintered zirconia specimen processed to a diameter of 15 mm and a thickness of 1 mm was fixed on a steel plate with resin cement (Super-Bond: Sun Medical), and steel balls of different weights (7 g, 14 g, 24 g, 33 g, 65 g, 112 g, 175 g, 261 g, 372 g, and 508 g; Figure 12) were dropped naturally from a height of 60 cm above the sintered zirconia specimen (Figure 13).



Figure 12 Steel balls used

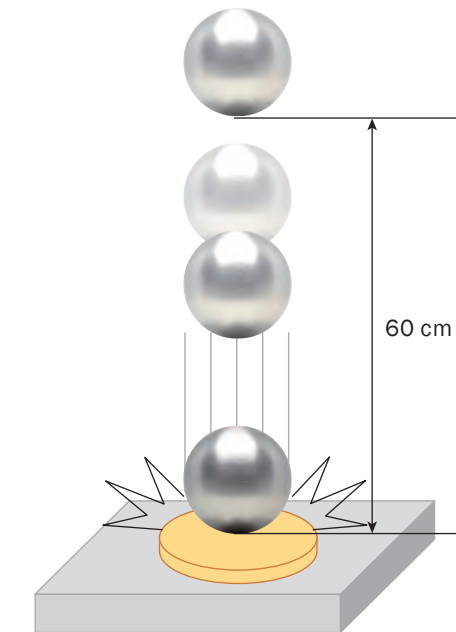

Figure 13 Test method of impact test

Firstly, starting from a small weight, a steel ball was dropped on each sintered zirconia specimen. The drop impact load was repeated three times with the steel ball of the same weight; heavy steel balls were then similarly dropped with and the impact was applied until the sintered body was broken. Table 3 shows the test results of repeated drop and impact loading. NANOZR was broken when a steel ball of 508 g was dropped three times. T was broken at the third drop of 175 g, HT was broken at the first drop of 65 g, and SHT was broken at the first drop of 33 g.

Table 3 Impact resistance of each sintered zirconia specimen in repeating impact loading

Steel ball	NANOZR			T			HT			SHT		
	1 <sup>st</sup>	2 <sup>nd</sup>	3 <sup>rd</sup>	1 <sup>st</sup>	2 <sup>nd</sup>	3 <sup>rd</sup>	1 <sup>st</sup>	2 <sup>nd</sup>	3 <sup>rd</sup>	1 <sup>st</sup>	2 <sup>nd</sup>	3 <sup>rd</sup>
7	○	○	○	○	○	○	○	○	○	○	○	○
14	○	○	○	○	○	○	○	○	○	○	○	○
24	○	○	○	○	○	○	○	○	○	○	○	○
33	○	○	○	○	○	○	○	○	○	×	—	—
65	○	○	○	○	○	○	×	—	—	—	—	—
112	○	○	○	○	○	○	—	—	—	—	—	—
175	○	○	○	○	○	×	—	—	—	—	—	—
261	○	○	○	—	—	—	—	—	—	—	—	—
372	○	○	○	—	—	—	—	—	—	—	—	—
508	○	○	×	—	—	—	—	—	—	—	—	—

Next, the steel ball was dropped once for each sintered specimen, that is, as a single impact loading. Three test specimens were tested with steel balls of each weight. The impact force at fracture was calculated from the weight of the steel ball at the time of fracture by using the following formula (7), even it was the first specimen of the 3 specimens. The falling velocity was fixed and the collision time was 1 ms. The result of the test was that each zirconia test specimen was broken at the same weight as the previous repeated impact loading. The impact force at the time of breakage of NANOZR was 1,742 N, and the impact resistance of NANOZR was 2 to 15 times or more than that of the yttria-type zirconia (Figure 14).

$$F = \frac{m \sqrt{2gh}}{\Delta t} \quad (7)$$

where

$F$  is the impact force [N].

$h$  is the falling distance [m].

$m$  is the weight of a steel ball [kg].

$\Delta t$  is the collision time [s].

$g$  is the acceleration of gravity [m/s<sup>2</sup>].

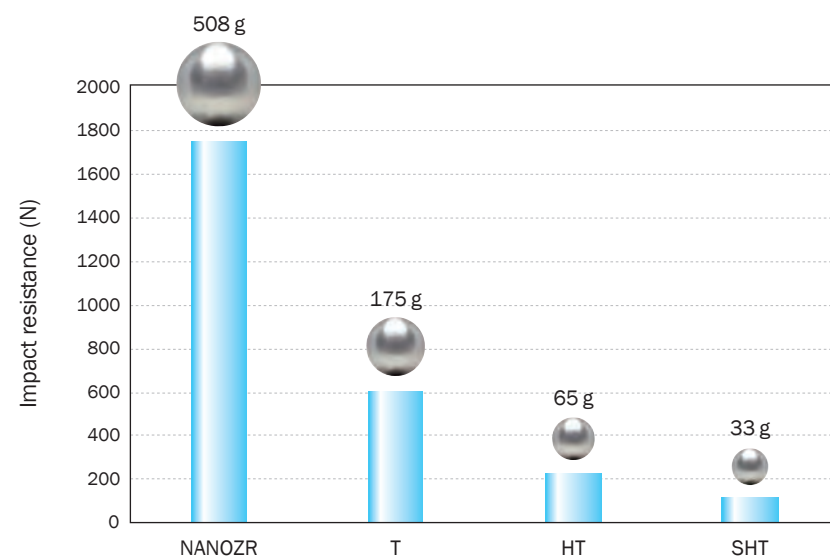

Figure 14 Impact resistance of each sintered zirconia specimen in a single impact loading

### 3.3 Coping break test assuming clinical practice

The fracture strength test of the sintered body modeled after a single crown coping, assuming a molar tooth, was carried out by the central loading method with a universal testing machine (EZ-Graph; Shimadzu) (Fig.15). The thickness of each zirconia coping was 0.5 mm (NANOZR had thicknesses of 0.5 mm and 0.3 mm), and the surface was buffed with 1 μm diamond paste.

Zirconia coping was fixed with resin cement (Super Bond; Sun Medical, cement space set to 100 μm). As the test conditions, a steel ball with a radius of 2 mm was loaded at the center of the upper surface of the specimen at a velocity of 1 mm/min, and the load until breaking was measured. A resin (KZR-CAD HR Block 3 GAMMATHETA: YAMAKIN), which has an elasticity coefficient close to natural tooth, was used for the abutment. The result of the test was that NANOZR exhibited high breaking strength at both coping thicknesses of 0.5 mm and 0.3 mm, compared to yttria-based zirconia (Fig.16). It was recognized that NANOZR has excellent mechanical characteristics combining the above instantaneous impact resistance and high breaking strength.

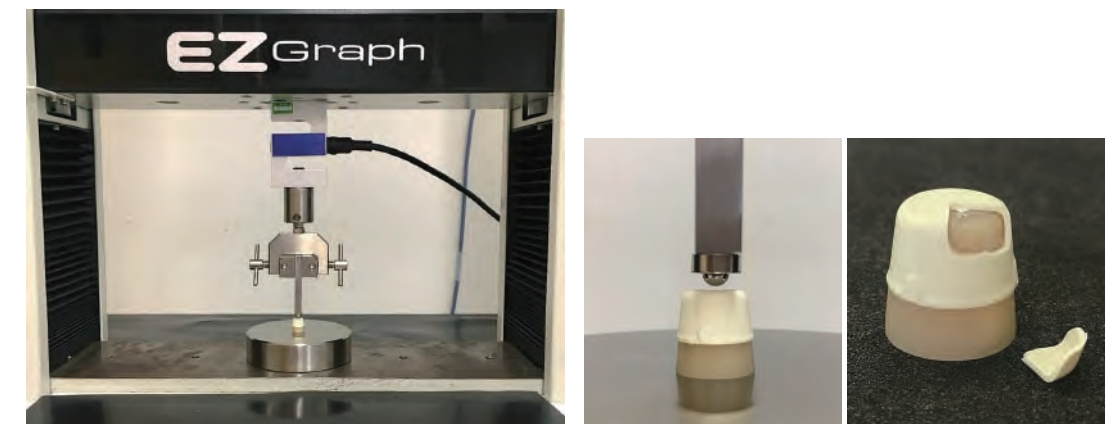

Figure 15 Test specimen for breaking-strength test assuming a single crown coping, and the tester

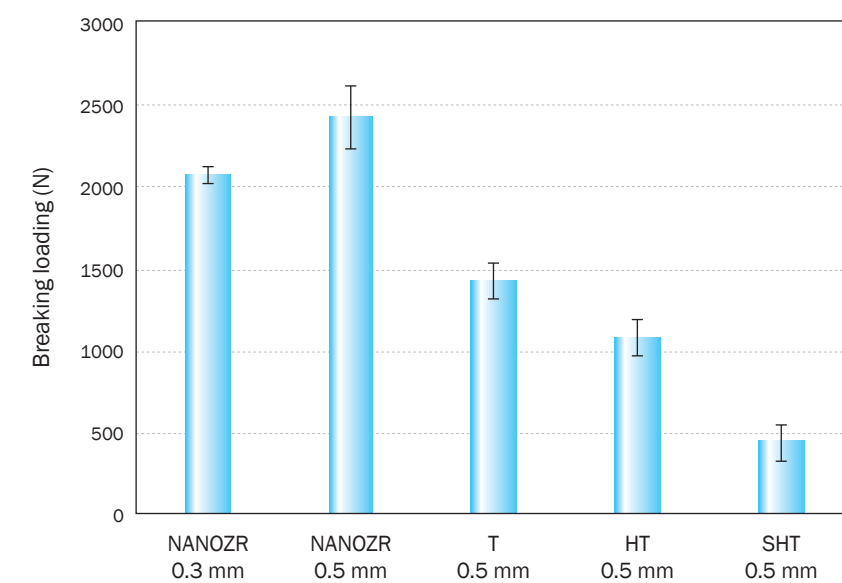

Figure 16 Breaking strength of each sintered zirconia specimen

## 4. Chemical properties

In the case of restorations to be placed in the oral cavity, chemical durability against saliva and food and drink is required; ceramics like zirconia have a strong bond strength between atoms and have excellent chemical durability. Metals dissolve as metal ions due to corrosion, accompanied in some cases by discoloration; however, ceramic is chemically stable and can maintain good aesthetics over long periods of time. As described above, corrosion of ceramic as an oxide in the oral cavity is thus unlikely, and it can be said that ceramic restorations are extremely stable compared with metal- and resin-type restorations. Its properties were verified by dissolution tests.

The dissolution amounts of NANOZR, T, HT, and SHT were measured in accordance with ISO 6872: 2015. For the test, six sintered zirconia specimens (10.0 mm × 25.0 mm × 1.0 mm) were prepared, and the total exposed surface area of the specimens was adjusted to 30 cm<sup>2</sup> or more. Sintered specimens were immersed in 100 mL of 4 vol% acetic acid aqueous solution at 80 °C for 16 hours, and the dissolution amount test was conducted (Figure 17).

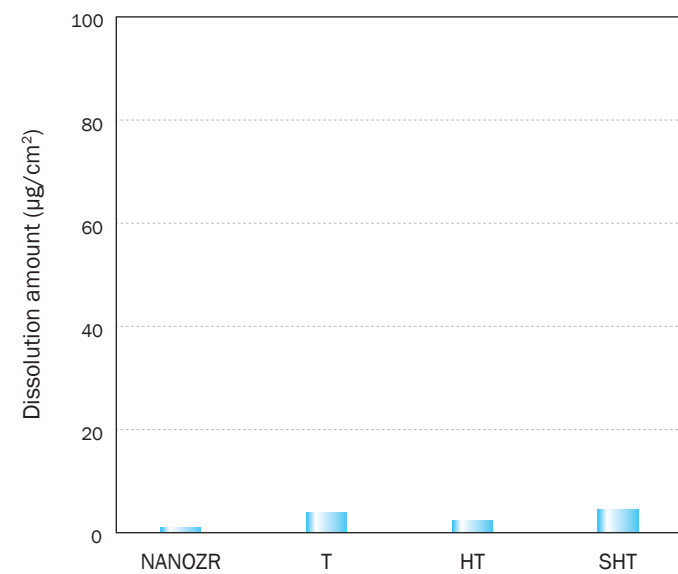

Figure 17 Dissolution amount of each sintered zirconia specimen

Although this test is an evaluation of conditions (pH 2.5, 80 °C.) more severe than the oral environment (average pH 6 to 7, 37 °C.), the dissolution amount of every specimen is minimal, and much lower than the standard reference value (100 µg/cm<sup>2</sup> or less (Class 6)) in ISO 6872: 2015.

## 5. Hydrothermal deterioration resistance property

Although zirconia shows excellent chemical durability, it has been reported that phase transformation (tetragonal to monoclinic) progresses even at a low temperatures close to body temperature in the presence of moisture<sup>12-15)</sup>, and deterioration under the presence of moisture in the oral cavity is a concern.

For evaluation of hydrothermal deterioration property, each mirror-polished sintered specimen (4.0 mm × 20.0 mm × 1.2 mm) of NANOZR, T, HT, and SHT was heated at 134 °C. using an autoclave apparatus (SM 310: Yamato Scientific Co., Ltd.), with water-vapor pressure at 0.2 MPa for 5 hours (equivalent to 15 to 20 years in water at 37 °C), and 30 hours (equivalent to 90 to 120 years)<sup>16, 17)</sup>. The hydrothermally treated specimen was measured by X-ray diffraction (CuKα, 40 kV, 20 mA, XRD, Ultima IV: Rigaku Corporation) in order to investigate the presence or absence of crystal phase transformation accompanying hydrothermal treatment, and the monoclinic ratio  $f_m$  was calculated from the Garvie-Nicholson equation (8)<sup>18)</sup>.

$$f_m = \frac{l_m(111) + l_m(11\bar{1})}{l_m(111) + l_m(11\bar{1}) + l_m(101) + l_c(111)} \times 100 \quad (8)$$

The monoclinic ratio of each of the hydrothermally treated test specimens was determined by X-ray diffraction, and the results are given in Table 4.

The monoclinic ratio of the as-sintered NANOZR was 4%, but after the hydrothermal treatment, the value became 5.3% in 5 hours, and 5.7% in 30 hours and the increase in monoclinic crystal was slight. On the other hand, the monoclinic ratio of each zirconia T, HT, and SHT, both untreated and treated for 5 hours, was 0%. By treatment for 30 hours, monoclinic crystals of 4.7% in T and 14.6% in HT were confirmed, but monoclinic crystals were not observed in SHT. The addition of alumina is known to suppress hydrothermal deterioration<sup>19)</sup>. HT is considered to be easily transformed into the monoclinic phase by hydrothermal treatment, since the content of alumina is less than that of T. SHT is a PSZ-type zirconia, with a larger proportion of Y<sub>2</sub>O<sub>3</sub> as a stabilizer than T or HT, and is a tetragonal and cubic eutectic. Therefore, as the proportion of tetragonal phase-transforming to monoclinic system decreases, the propagation of stress or strain due to the volume expansion accompanying phase transformation is suppressed by cubic crystal; as a result, in SHT, the phase from tetragonal to monoclinic transformation hardly occurred, and it is thought that this is why monoclinic crystals were not observed.

Table 4 The monoclinic ratio after aging treatment with an autoclave under steam at 134 °C

Item	Aging time (hr)		
	0	5	30
NANOZR	4.0	5.3	5.7
T	0	0	4.7
HT	0	0	14.6
SHT	0	0	0

## 6. Adhesion

NANOZR has high strength and toughness and is effective as a frame material for long span bridges. Figure 18 shows an example of the use of a bone-anchored bridge frame made of NANOZR. Since NANOZR can be designed with less thickness than yttria-type zirconia, reduced risk of fracture is expected.

Also, clinical application as a frame for denture bases, utilizing the toughness of NANOZR, has been proposed. It is also possible to bond a resin crown onto a denture base made of NANOZR or to build with resin directly on a frame.

In this section, we introduce the results of evaluating adhesion between resin material and NANOZR.



Figure 18 Bone-anchored bridge frame made of NANOZR  
(Fixed with a titanium-base abutment and resin cement)

Adhesive resin cement is used when adhering a resin crown to NANOZR frame. As a pretreatment, sand-blast treatment is applied to the adhesion surface to increase the adhesion area. After that, it is essential to apply primer or a bonding material containing a phosphoric acid monomer or a silane coupling agent or the like on the surface of the zirconia in order to chemically bond with the adhesive resin cement and to resinify the surface of the zirconia.

Adhesive resin cement and the surface treatment material shown in Table 5 were adhered to NANOZR and the comparative specimen SHT by the method shown in Figure 20, so as to be their bonded cross-section as in Figure 19, and test specimens were fabricated.

These test specimens were installed in a small tabletop material tester (EZ-Graph: Shimadzu Corporation), and the tensile bond strength was measured by a tensile test at a crosshead speed of 0.5 mm/min. In this test method, no peeling occurred between the stainless steel rod and the resin cement.

Table 5 Adhesive resin cement and surface treatment materials

Manufacturer	Sun Medical	3M	Tokuyama Dental	GC		Shofu	Kuraray Noritake	BISCO	Kerr
Product name	Super Bond (Powder-liquid)	RelyX™ Ultimate Resin Cement	ESTECEM	G-CEM CERASMART	G-CEM LinkForce	Block HC Cem	PANAVIA® V5	Duo-Link™	Maxcem Elite™ Chroma
Type of resin cement	Combined with primer	Combined with bonding material	Combined with primer	Self-adhesive type	Combined with primer	Self-adhesive type	Combined with primer	Combined with bonding material	Self-adhesive type
Primer, Bonding material	Super Bond PZ PRIMER (2 liquids)	Scotchbond™ Universal Adhesive	TOKUYAMA UNIVERSAL PRIMER (2 Liquids)	Unnecessary	G-MULTI PRIMER	Unnecessary	CLEARFIL® CERAMIC PRIMER PLUS	All-Bond Universal	Unnecessary

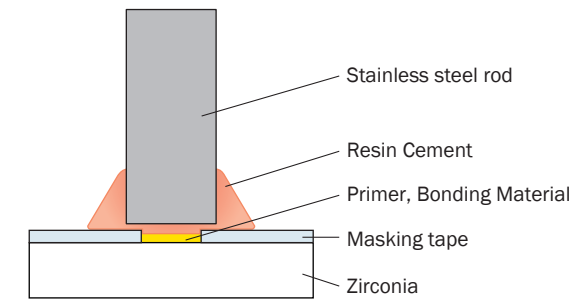

Figure 19 Image of bonded cross-section

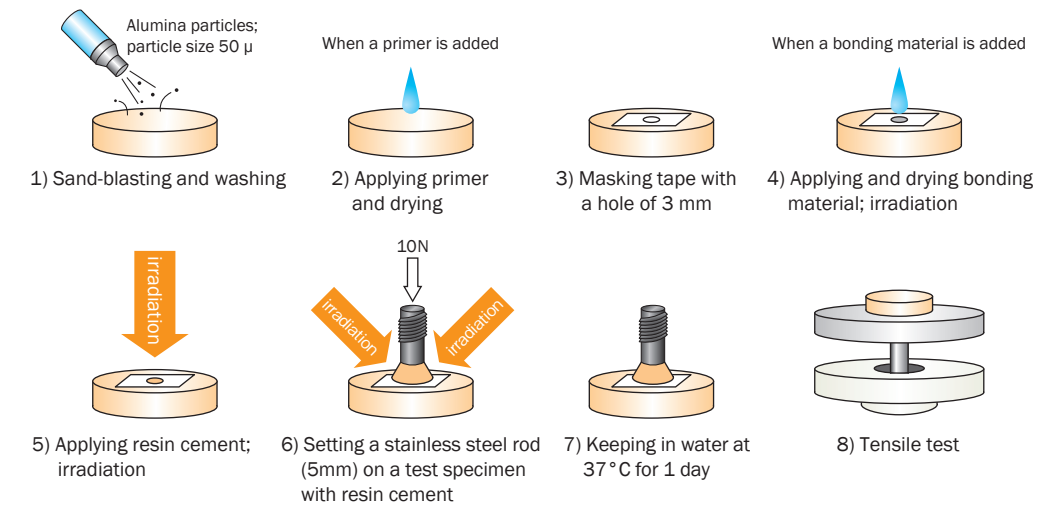

Figure 20 Method of tensile adhesion test

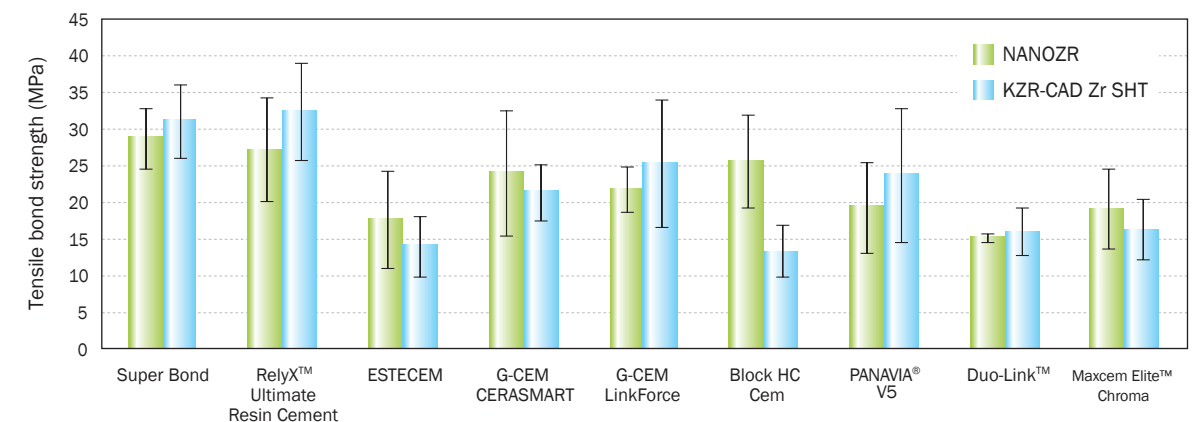

Figure 21 Initial tensile bond strength of NANOZR and SHT with each resin cement.

As shown in Figure 21, the tensile bond strength between zirconia and resin cement is 10 MPa or more for all adhesive resin cements. The high tensile bond strength of 25 MPa or more was obtained when "Super Bond," "RelyX™ Ultimate Resin Cement," and "Block HC Sem" were used for NANOZR.



Depending on the type of zirconia, the tensile bond strength with each adhesive resin cement was slightly different. Particularly with Block HC Cem, NANOZR showed tensile bond strength about twice that of SHT. The difference in tensile bond strength is thought to be influenced by the material of NANOZR and SHT, and the adhesive component of the resin cement, primer and bonding material. In addition, NANOZR shows a bonding strength of 20 MPa or more even with a self-adhesive type resin cement, and it can be said that high adhesive strength can be obtained without using a primer or a bonding material in combination.

## 7. Biocompatibility

NANOZR is a dental medical device (ceramics for dental milling and machining). Any medical device which comes into contact with the human body needs assessments of biological safety for the patient or the user. These assessments include cytotoxicity, sensitization and genetic toxicity.

In this section, we describe the evaluation of the cytotoxicity of NANOZR on THP.1 cells and on human acute monocytic leukemia cells by the trypan blue dye exclusion test<sup>20)</sup>, which is a direct contact test.

NANOZR, T, HT, and SHT were used as test specimens. Each test specimen was milled and sintered to a disc-like shape with diameter of 15 mm and a thickness of 1 mm, and then mirror-polished.

When cells are cultured on test specimens with cytotoxicity, the cell membranes are damaged by the cytotoxic component. Trypan blue can stain dead cells with damaged cell membranes, while it cannot stain living cells. Therefore, the trypan blue dye exclusion test can evaluate the effect of a sample on cell proliferation and viability by counting clear cells (living cells) and stained cells (dead cells) with a hemacytometer (Figure 22).

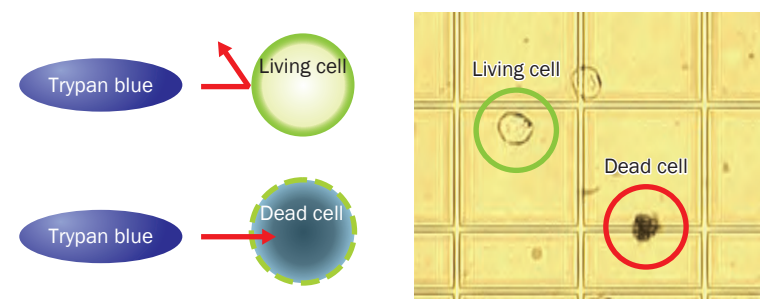

Figure 22 Principle of Trypan blue exclusion test

Each test specimen was placed in a well of a 24-well plate. One mL of THP.1 cells (100,000 cells/mL) was seeded, and then incubated for 3 days at 37 °C under 5% CO<sub>2</sub>. Fifty μL of the cultured cells were mixed with the same amount of trypan blue. Living cells and dead cells were individually counted by the hemocytometer. Cells cultured without test specimen were used as reference.

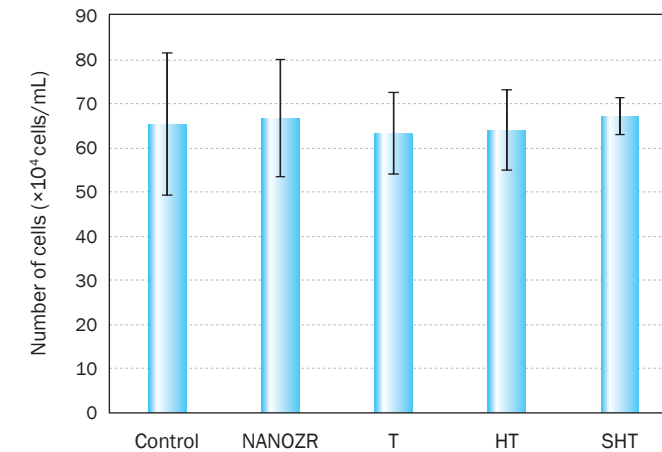

Figure 23 Influence of each dental zirconia on THP.1 Cells (Cell number)

Figure 23 shows cell proliferation of THP.1 cells cultured on each test specimen.

The number of cells cultured on each zirconia sample increased from 100,000 cells/mL at seeding to 600,000 cells/mL or more. In addition, there were no significant difference between the dental zirconia samples and the reference.

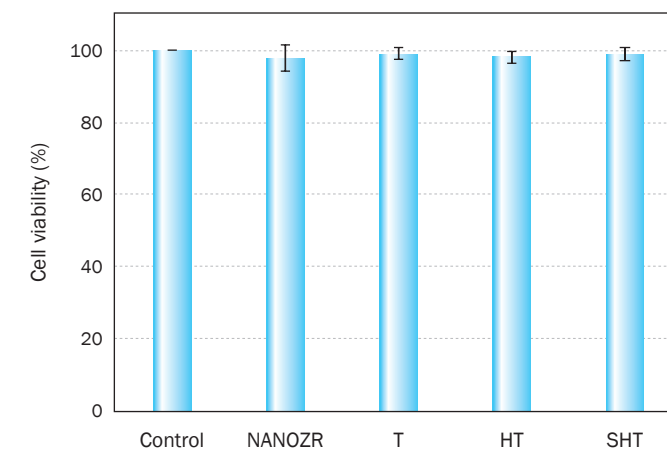

Figure 23 Influence of each dental zirconia on THP.1 Cells (Cell viability)

In addition, each test specimen also exhibited high cell viability (> 95%) as shown in Figure 24.

As described above, none of the zirconia test specimens, including NANOZR, showed cytotoxicity in cell number and cell viability of THP.1 cells.

As described in "4. Chemical Properties," zirconia is a material with excellent chemical durability. In the dissolution test of "KZR-CAD NANOZR," only ultra-trace amounts of zirconium were detected. Some investigations have reported that the biological safety of zirconium is equal to or higher than that of titanium, which has excellent biocompatibility<sup>21)</sup>. Therefore, it is considered that the results of the cytotoxicity test were based on the characteristics of the dental zirconia products, which excel not only in the chemical durability of the material, but also in biological safety of the components.

## 8. Conclusion

NANOZR showed higher values than yttria-based zirconia in terms of strength, especially fracture toughness value, and in impact test. NANOZR is a material that enables a thickness of crown/bridge frame of 0.3 mm, the same as metal, taking advantage of this characteristic.

The light transmission of NANOZR is lower than that of yttria-type zirconia. However, this is not only a disadvantage; it can cancel out the influence of the material and color tone of abutment teeth, so that it has also the advantage that the same building-up technique can be performed as for porcelain fused to metal crown.

In terms of strength and aesthetics, NANOZR can be thought of as a material positioned between dental bonding alloy and yttria-based zirconia. It can also be called a new choice in materials. In view of the metal allergy problem, there is a demand for metal-free materials, and NANOZR, which has properties closer to metals than yttria-type zirconia, is expected to play an active part as a substitute material for metals.

In this report, we have mainly introduced the mechanical properties of NANOZR, but it has also been reported that it exhibits excellent features in terms of biocompatibility, especially in connectivity with the oral mucosal tissue. Further research is therefore desired in the future.

## References

- 1) U Raap, M Stiesch, H Reh, A Kapp, T Werfel: Investigation of contact allergy to dental metals in 206 patients. *Contact Dermatitis*. 60(6):339-343, 2009.
- 2) S. BAN: Properties of zirconia for realization of all-ceramic restoration. The Journal of the Tokyo Dental College Society, 107(6): 670-684,2007.
- 3) R. C. Garvie, R. A. Haaink, R. T. Pascoe: Ceramic steel. *Nature*, 258: 703-704, 1975.
- 4) M. Nawa, N. Bamba, T. Sekino, K. Niihara: The effect of TiO<sub>2</sub> addition on strengthening and toughening in intragranular type of 12Ce-TZP/Al<sub>2</sub>O<sub>3</sub> nanocomposites. *J. Europ. Ceram. Soc.*, 18 (3):209-219, 1998.
- 5) M. Nawa, S. Nakamoto, T. Sekino, K. Niihara: Tough and strong Ce-TZP/Alumina nanocomposites doped with titania. *Ceram. Int.*, 24(7): 497-506, 1998.
- 6) S. Ban, M. Nawa, Y. Suehiro, H. Nakanishi: Mechanical Properties of Zirconia/Alumina Nano-Composite after Soaking in Various Water-Based Conditions, *Key. Engin. Mater.*, 309-311, 1219-1222, 2006.
- 7) M. Nawa: Ceria-stabilized tetragonal zirconia based nanocomposite for biomedical applications, *J. J. Soc. Dent. Mater. Devic.*, 31(4): 289-292, 2012.
- 8) ISO 6872: 2015 - Dental ceramic materials.
- 9) ISO 14065: 2000 - Test methods for hardness of fine ceramics.
- 10) ISO 15732: 2003 - Testing methods for fracture toughness of fine ceramics at room temperature.
- 11) K. Niihara, R. Morena, D. P. H. Hasselman: Evaluation of K<sub>Ic</sub> of brittle solids by the indentation method with low crack-to-indent rations. *J. Mater. Sci. Lett.*, 1: 13-16, 1982.
- 12) J. Chevalier, B. Cales, J. M. Drouin: Low-temperature aging of Y-TZP ceramics. *J. Am. Ceram. Soc.*, 82: 2150-2154, 1999.
- 13) S. BAN: Zirukonia kei zairyuu no shurui to tokusei (Kinds and characteristics of zirconia materials. T. MIYAZAKI, H. MIURA, K. KIMURA (ed.): Design Operation Clinical Zirconia Restoration. The International Journal of Dental Technology EXTRA ISSUE, Tokyo, Ishiyaku Pub, Inc. 22-37, 2010.
- 14) C. L. Maria, S. S. Susanne, A. Patrick, J. Mare, H. W. Anselm: Low-temperature degradation of a Y-TZP dental ceramic. *Acta. Biomater.*, 7: 858-865, 2011.
- 15) I. Yamashita, K. Tsukuma: Phase Separation and Hydrothermal Degradation of 3 mol% Y<sub>2</sub>O<sub>3</sub>-ZrO<sub>2</sub> Ceramics. *J. Ceram. Soc. J.*, 113(8): 530-533, 2005.
- 16) J. Chevalier, J. M. Drouin, B. Cales: Low temperature ageing behavior of zirconia hip joint heads. *Bioceramics*, 10:135-137, 1997.
- 17) J. Chevalier, L. Gremillard, S. Deville: Low-temperature degradation of zirconia and implications for biomedical implants. *Annu. Rev. Mater. Res.*, 37: 1-32, 2007.
- 18) R. C. Garvie, P. S. Nicholson: Phase Analysis in Zirconia Systems. *J. Am. Ceram. Soc.*, 55(6): 303-305, 1972.
- 19) H. Fujisaki, K. Kawamura, K. Imai: Zirconia powder for translucent dental zirconia: Zpex. *Tosoh research & technology review*, 56: 57-61, 2012.
- 20) Correa GT, Veranio GA, Silva LE, Hirata Junior R, Coil JM, Scelza MF: Cytotoxicity evaluation of two root canal sealers and a commercial calcium hydroxide paste on THP1 cell line by Trypan Blue assay. *J. Appl. Oral Sci.*, 17(5): 457-461, 2009.
- 21) M. FUJITA: *In Vitro* Study on Biocompatibility of Zirconium and Titanium. *J. stomatol. Soc. Jpn*, 60 (1): 54-65, 1993.

## Lineup

### KZR-CAD NANOZR

KZR-CAD NANOZR



NANOZR	Diameter(Φ) 98.3mm									
	Thickness ( t )									
	10 mm	12 mm	14 mm	16 mm	18 mm	20 mm	22 mm	25 mm	30 mm	35 mm
	●	●	●	●	●	●	●	●	●	●

### KZR-CAD Zr

KZR-CAD Zr T/HT/SHT



Color shade		Diameter(Φ) 98.5mm									
		Thickness ( t )									
		10 mm	12 mm	14 mm	16 mm	18 mm	20 mm	22 mm	25 mm	30 mm	35 mm
T	White	—	—	●	●	●	●	●	●	—	—
HT		—	—	●	—	—	●	—	●	—	—
SHT		—	—	●	—	●	●	—	—	—	—
HT-A1, HT-A2, HT-A3, HT-A3.5	Colored	—	—	●	—	—	●	—	●	—	—
SHT-A1		—	—	●	—	—	●	—	—	—	—
SHT-A2, SHT-A3, SHT-A3.5		—	—	●	—	●	●	—	—	—	—

## 《Previously Published Technical Reports》

- Technical Report on ZEO CE LIGHT (Aug. 2002)
- Technical Report on Luna-Wing (May 2007)
- Technical Report on TWiNY (Jul. 2010)

## 《Previously Published Safety Test Reports》

- Vol. 1 Pursuing International Standards in Quality and Safety (Dec. 2004)
- Vol. 2 ZEO METAL Series Elution Test and in Vitro Cytotoxicity Test (Jun. 2005)
- Vol. 3 Elution Test and in Vitro Cytotoxicity Test of Precious-Metal Alloys and Gold Alloys for Metal Ceramic Restoration Use (Dec. 2005)
- Vol. 4 Biological Evaluation of Luna-Wing (Jun. 2006)
- Vol. 5 Report on Physical Properties and Safety of High-Carat Gold Alloys (Oct. 2007)
- Vol. 6 Examination of the Biological Impact of the Physical Properties of Dental-Material Alloys and Gold Alloys for Hard Resin and Metal Ceramic Restoration Use (May 2008)
- Vol. 7 Report on the Physical Properties and Safety of the Gold Alloy Nexo-Cast (Oct. 2008)
- Vol. 8 Biological Evaluation of the Hybrid Composite Resin, TWiNY (Jun. 2010)
- Vol. 9 Chemical and Biological Characteristics of Precious-Metal Alloys: Elution Characteristics Produced Through Mixture with Titanium (Feb. 2011)
- Vol. 10 Physical Properties and Safety of the Precious-Metal Alloy for Metal Ceramic Restoration Use Brightis (Oct. 2011)
- Vol. 11 Physical Properties and Safety of the Dental Adhesive, Multi Primer (Mar. 2014)
- Vol. 12 Safety of the Dental Pulp Capping Material, TMR-MTA CEMENT (Jan. 2018)

## 《Previously Published Macromolecule Technology Reports》

- Vol. 1 The Polymerization of Dental Materials: The Basis of Radical Polymerization (1) (Oct. 2009)
- Vol. 2 The Polymerization of Dental Materials: The Basis of Radical Polymerization (2) (Feb. 2010)
- Vol. 3 The Polymerization of Dental Materials: Restoration-Material Monomers (1) (Mar. 2010)
- Vol. 4 The Polymerization of Dental Materials: Restoration-Material Monomers (2) (Jul. 2010)
- Vol. 5 The Polymerization of Dental Materials: The Influence of Oxygen (Aug. 2011)
- Vol. 6 The Polymerization of Dental Materials: Primers and Developers (Oct. 2012)
- Vol. 7 Polymerization Silane Coupling Agent: Methacrylic Resin (Acrylic Resin) (Jun. 2013)
- Vol. 8 Shrinkage of Dental Composite in Polymerization (Nov. 2014)
- Vol. 9 Application of Iodonium Salt as Initiator Component in Dental Material (Mar. 2017)
- Vol.10 Application of Nanogel to Dental Resin and Adhesive (Jun. 2018)

## 《All Previously Published Science Reports》

- Vol. 1 Dental Surgery and Bisphosphonate Formulation (Aug. 2010)
- Vol. 2 Reactive Oxygen: Its Generation, Elimination and Effects (Nov. 2011)
- Vol. 3 The Hypoxic World (Jul. 2012)
- Vol. 4 Recent Progress in the Regeneration of Tooth Material (Feb. 2014)
- Vol. 5 Application of Fluoride and Its Effect (Oct. 2016)

## 《Previously Published Product Reports》

- Basic Information and Product Report on Zirconia (Feb. 2014)
- Basic Information and Product Report on Titanium (Jun. 2016)
- Basic Information and Product Report on Hybrid Resin for CAD/CAM use (Sep. 2014)
- Basic Information and Product Report on Dental Restorative Material (Sep. 2015)
- Basic Information and Product Report on Dental Bonding Material (Jan. 2016)
- TMR-MTA CEMENT Product Report (Aug. 2017)
- Multi Primer Series Product Report (Oct. 2017)
- KZR-CAD HR BLOCK 3 GAMMATHETA Product Report (Jan. 2018)

The actual color of the product, model and package may differ from the photographs due to printing ink and shooting conditions.

Manufactured by

**YAMAKIN CO., LTD.** 1090-3 Otani, Kamibun, Kagami-cho, Konan-shi, Kochi, 781-5451 Japan

Editor: Takahiro Kato

Publisher: Shigenari Yamamoto

Date of publication: 31 JAN. 2019